



Charlottesville, VA USA
www.isotemp.com

OCXO 82-1003

PHONE: (434) 295-3101
FAX: (434) 977-1849

CRYSTAL OSCILLATOR SPECIFICATION

This specification defines the operating characteristics of an ovenized crystal oscillator. Long term stability is assured through use of premium components.

REV	DESCRIPTION OF REVISION	BY	APV	DATE
-		BTG	TST	03-04-2006

ISOTEMP RESEARCH INC. CHARLOTTESVILLE, VA. USA	CODE ID	MODEL NO.	PAGE OF TOTAL		DWG. NO.	REV.
	31785	OCXO 82-1003	1	2	114-1243	-



Charlottesville, VA USA
www.isotemp.com

OCXO 82-1003

- 1. OUTPUT (PIN = "R.F. OUTPUT")
 - 1.1. Frequency 8.192 MHz
 - 1.2. Waveform Rectangular
 - 1.3. Level TTL / HCMOS
 - a. "1" level > +4.4 V
 - b. "0" level < +0.4 V
 - 1.4. Load 3 TTL
 - 1.5. Duty cycle 45% to 55% @ +2.5 V
 - 1.6. Rise/fall time < 6 ns (10% to 90%)
 - 1.7. Spurious < -60 dBc

- 2. FREQUENCY STABILITY
 - 2.1. Ambient < $\pm 1 \times 10^{-8}$, 0°C to +60°C
(referenced to +30°C)
 - 2.2. Aging
 - a. At time of shipment < $\pm 1 \times 10^{-9}$ /day
 - b. After indefinite storage
 - i. Daily < $\pm 1 \times 10^{-9}$ after 30 days
 - ii. Yearly < $\pm 1 \times 10^{-7}$
 - iii. 10 years < $\pm 4 \times 10^{-7}$
 - 2.3. Voltage < $\pm 5 \times 10^{-9}$ /±10% change
 - 2.4. Short term < 5×10^{-11} /second
root Allan variance
 - 2.5. Warm-up/Retrace < $\pm 2 \times 10^{-8}$ after 0.5 hour
(referenced to turn-off frequency
after specified aging is met, and
following 24 hours off power)
(at constant temperature and voltage)
 - 2.6. Phase noise
 - a. @ 10 Hz < -120 dBc
 - b. @ 100 Hz < -140 dBc
 - c. @ 10 kHz < -150 dBc

- 3. MECHANICAL FREQUENCY ADJUSTMENT
 - 3.1. Range > $\pm 4 \times 10^{-7}$
 - 3.2. Resolution < $\pm 4 \times 10^{-9}$
 - 3.3. Control Multi-turn trimmer

- 4. INPUT POWER (PIN = "+VDC")
 - 4.1. Voltage +12 V ±10%
 - 4.2. Current < 400 mA @ turn on
 - 4.3. Steady state < 2 Watts @ +25°C

- 5. MECHANICAL
 - 5.1. Applicable series OCXO 82 series
 - 5.2. Model number OCXO 82-1003
 - 5.3. Outline drawing 125-530

ISOTEMP RESEARCH INC. CHARLOTTESVILLE, VA. USA	CODE ID	MODEL NO.	PAGE OF TOTAL		DWG. NO.	REV.
	31785	OCXO 82-1003	2	2	114-1243	-

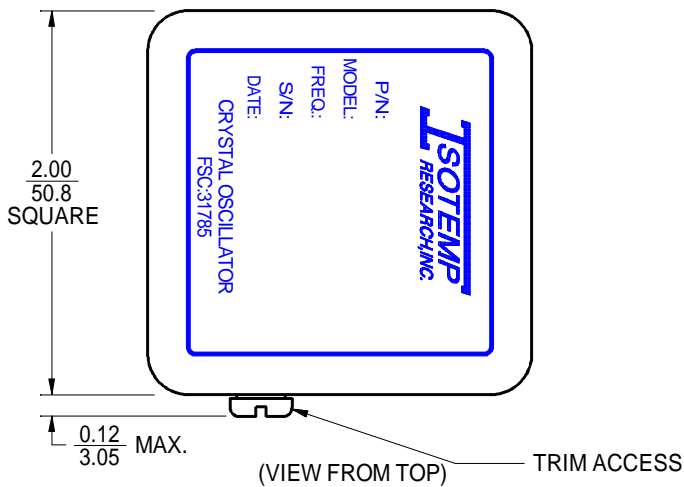

PIN CONNECTIONS	
PIN	FUNCTION
1	+VDC
2	R. F. OUTPUT
3	0 VOLTS & CASE
4 (See Note 1)	VCO INPUT or NOT CONNECTED

Note 1. If the specification does not specify parameters for PIN4 then PIN4 is NOT internally CONNECTED.

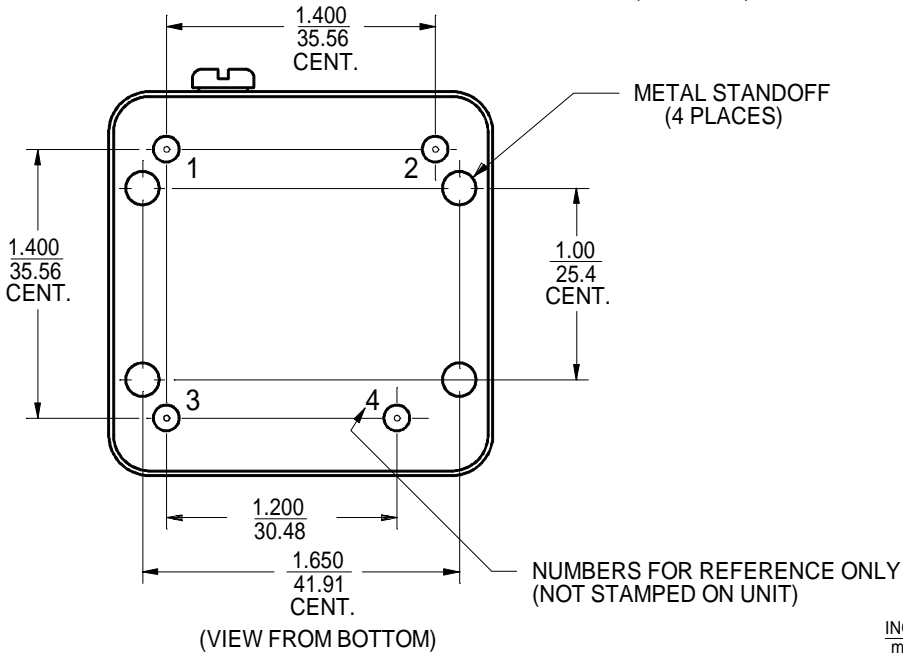
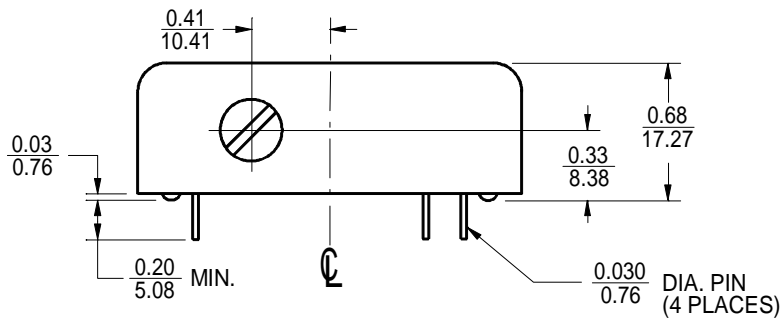

$\frac{\text{INCH}}{\text{mm}}$ (REFERENCE ONLY)

Form NO. 120-081E



OSCILLATORS

Charlottesville, Virginia USA

NAME: OUTLINE DRAWING
(OCXO 82 SERIES)

CODE I.D. NO.
31785

SCALE: 1:1
DWN. BY: PAD

DATE: 11-11-1997
APPR'D. BY: DAG

LET	REVISION	BY	APP	DATE
A	ADDED METRIC DIMENSIONING AND REVISED PINOUTS.	LRB	DAG	01-02-02

TOLERANCES	
UNLESS OTHERWISE SPECIFIED:	
ANGLES: ±1 DEGREE	
FRACTIONS: ±1/32 INCH	
DECIMALS: .XX ± .015, .XXX ± .010 INCH	
MATERIAL: COLD ROLLED STEEL	
FINISH: BRIGHT NICKEL	
MARK: LABEL	

DWG: 125-530
REV: A
SHT: 1 OF 1